



# UFM

## Ultrasonic Flowmeter

### User Manual



©Copyright 2012 Dwyer Instruments, Inc.

Printed in U.S.A. 9/12

**DWYER INSTRUMENTS, INC.**  
P.O. BOX 373 • MICHIGAN CITY, INDIANA 46360, U.S.A.

Phone: 219/879-8000  
Fax: 219/872-9057

www.dwyer-inst.com  
e-mail: info@dwyer-inst.com



## Table of Contents

|       |  |    |
|-------|--|----|
| 1     | General Description .....                          | 4  |
| 2     | How does it work? .....                            | 5  |
| 3     | User interface.....                                | 6  |
| 3.1   | Key switches.....                                  | 6  |
| 4     | Installing the UFM.....                            | 7  |
| 4.1   | Preparation .....                                  | 8  |
| 4.2   | Sensor separation .....                            | 8  |
| 4.3   | Adaptors for small pipes .....                     | 10 |
| 4.4   | Attaching the UFM to the pipe .....                | 11 |
| 4.5   | UFM interface cable.....                           | 12 |
| 4.6   | Connecting the UFM to the Supply.....              | 12 |
| 4.7   | Pulse Output connection .....                      | 12 |
| 4.8   | Current Output.....                                | 13 |
| 4.9   | Cable Screen.....                                  | 13 |
| 5     | Powering up for the first time.....                | 14 |
| 5.1   | How to enter the Pipe ID .....                     | 15 |
| 5.2   | Pulse output.....                                  | 16 |
| 5.2.1 | Volumetric mode .....                              | 16 |
| 5.2.2 | Frequency mode .....                               | 16 |
| 5.3   | 4-20 mA Current output.....                        | 16 |
| 6     | Subsequent Power-ON Sequence .....                 | 17 |
| 7     | Password Controlled Menus.....                     | 17 |
| 7.1   | General procedure for changing menu settings ..... | 17 |
| 7.1.1 | Selection menus.....                               | 17 |
| 7.1.2 | Data entry menus.....                              | 18 |
| 7.2   | User Password controlled menu structure .....      | 18 |
| 8     | Diagnostics Menu.....                              | 23 |
| 9     | Relocation of guide rail .....                     | 24 |
| 10    | Appendix I – UFM Specification .....               | 25 |
| 11    | Appendix II – Default values .....                 | 26 |
| 12    | Appendix III – Error and Warning Messages.....     | 27 |



---

|      |                          |    |
|------|--------------------------|----|
| 12.1 | System errors .....      | 27 |
| 12.2 | Warnings .....           | 27 |
| 13   | Maintenance/Repair ..... | 28 |
| 14   | Warranty /Return.....    | 28 |



## 1 General Description

The UFM is a fixed installation, clamp-on flowmeter that is easy to install and requires minimum information to be entered by the user. Both the electronics and guide rail housings form an integral unit that is attached to the pipe using the supplied jubilee clips. Power to the unit is provided by an external 12 – 24 V ac/dc power supply. The UFM is intended to operate on steel, copper and plastic pipes with OD's in the range 0.98 inches (24.9 mm) to 4.62 inches (117.4 mm).

Compact, rugged and reliable, the UFM has been designed to provide sustained performance in industrial environments.

UFM standard features include:

- 2 line x 16 character LCD with backlight
- 4-key keypad
- Isolated pulse output
- 4-20 mA current output
- Simplified guide rail and transducer assembly
- Continuous signal monitoring
- Password protected menu operation for secure use
- Operates from external 12 to 24 V ac/dc power supplies
- Small pipe adaptors

Typical applications

- Hot water metering and flow measurement
- Flow measurement for heat metering
- Chilled water metering and flow measurement
- Potable water metering and flow measurement
- Process water metering and flow measurement
- Ultra pure water metering and flow measurement.

## 2 How does it work?

The UFM is a clamp-on, ultrasonic flowmeter that uses a multiple slope transit time algorithm to provide accurate flow measurements.

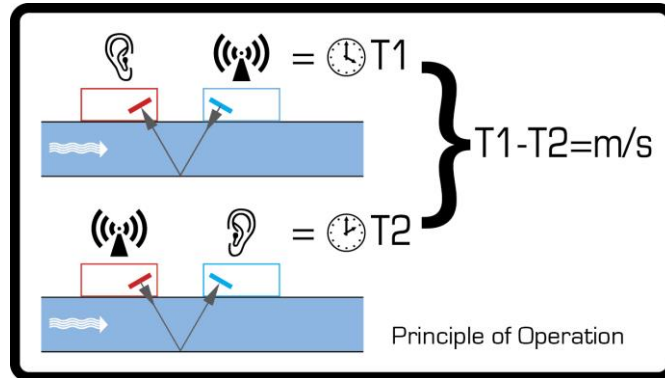

Figure 1 Principle of Transit-Time operation

An ultrasonic beam of a given frequency is generated by applying a repetitive voltage pulse to the transducer crystals. This transmission goes first from the Downstream transducer to the Upstream transducer (red) as shown in the upper half of Figure 1. The transmission is then made in the reverse direction, being sent from the Upstream transducer (red) to the Downstream transducer (blue) as shown in the lower half of Figure 1. The speed at which the ultrasound is transmitted through the liquid is accelerated slightly by the velocity of the liquid through the pipe. The subsequent time difference  $T1 - T2$  is directly proportional to the liquid flow velocity.

### 3 User interface

Figure 2 illustrates the UFM user interface comprising of :

- One 2 line x 16 character LCD with backlight
- Four tactile key switches
- Two LED's



Figure 2 UFM User Interface

#### 3.1 Key switches



Selection key. Allows the user to select between options on the display.



Used to increment the value of each digit in numeric entry fields.



Used to decrement the value of each digit in numeric entry fields.



Used to enter the selection displayed or terminate the data entry. Pressing this key will take the user to another menu or to the Flow Reading screen.



4-20 mA LED is illuminated when the 4-20 mA output is ON



Pulse LED is illuminated when the Pulse output is ON

## 4 Installing the UFM

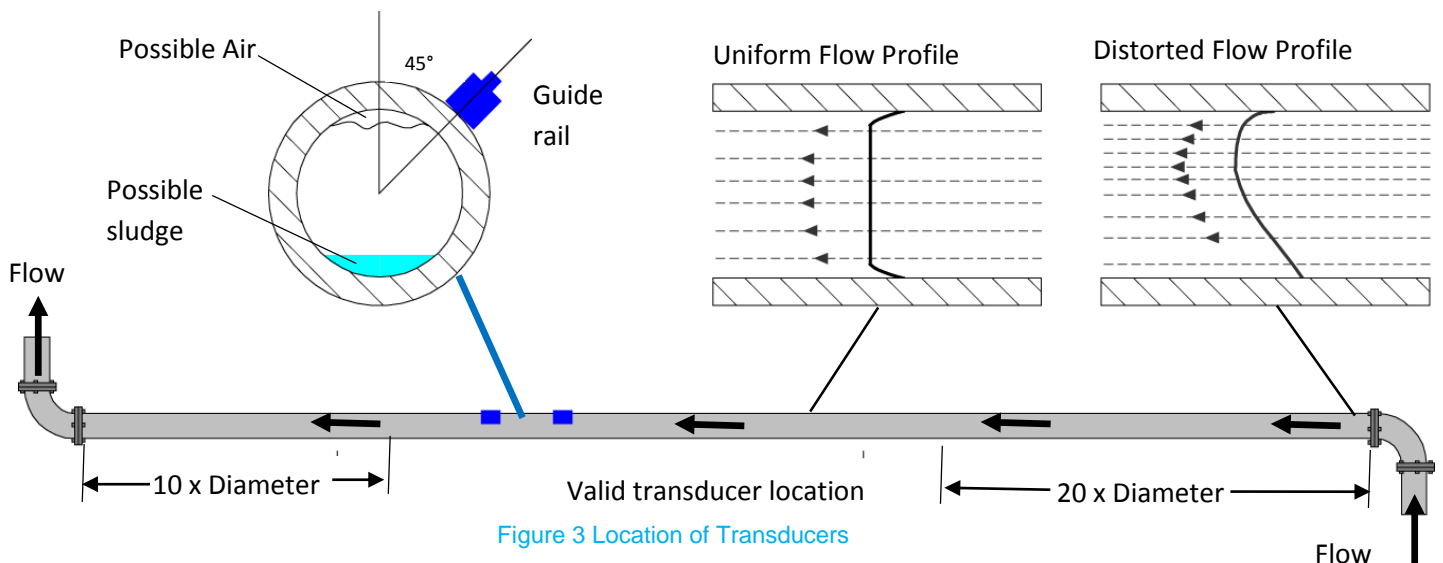

Figure 3 Location of Transducers

In many applications an even flow velocity profile over a full 360° is unattainable due to the presence of air turbulence at the top of the flow and possibly sludge at the bottom of the pipe. Experience has shown that the most consistently accurate results are achieved when the transducer guide rails are mounted at 45° with respect to the top of the pipe.

The UFM equipment expects a uniform flow profile, as a distorted flow will produce unpredictable measurement errors. Flow profile distortions can result from upstream disturbance such as bends, tees, valves, pumps and other similar obstructions. To ensure a uniform profile the transducers must be mounted far enough away from any cause of distortion such that it no longer has an effect.

To obtain the most accurate results the condition of both the liquid and the pipe must be suitable to allow ultrasound transmission along the predetermined path. It is important that liquid flows uniformly within the length of pipe being monitored, and that the flow profile is not distorted by any upstream or downstream obstructions. This is best achieved by ensuring there is a straight length of pipe upstream of the transducers of at least 20 times the pipe diameter, and 10 times the pipe diameter on the downstream side, as shown in Figure 3. Flow measurements can be made on shorter lengths of straight pipe, down to 10 diameters upstream and 5 diameters downstream, but when the transducers are mounted this close to any obstruction the resulting errors can be unpredictable.

**Key Point:** Do not expect to obtain accurate results if the transducers are positioned close to any obstruction that distorts the uniformity of the flow profile.



### 4.1 Preparation

1. Before attaching the transducers first ensure that the proposed location satisfies the distance requirements shown in Figure 3 otherwise the resulting accuracy of the flow readings may be affected.

2. Prepare the pipe by degreasing it and removing any loose material or flaking paint in order to obtain the best possible surface. A smooth contact between pipe surface and the face of the transducers is an important factor in achieving a good ultrasound signal strength and therefore maximum accuracy.

### 4.2 Sensor separation

The sensor must be positioned at the correct distance for the pipe size and type they will be used on. The table shown in Figure 4 gives the separation code for a given pipe material and outside diameter. This code will be displayed whenever the pipe inside diameter and material are prompted for.

#### Pipe OD range (inches)

|    | Pipe Material          |                        |                        |                        |
|----|------------------------|------------------------|------------------------|------------------------|
|    | Plastic & Copper       |                        | Steel                  |                        |
|    | Minimum                | Maximum                | Minimum                | Maximum                |
| B1 | 0.98 inches (24.9 mm)  | 1.22 inches (31.0 mm)  |                        |                        |
| A2 | 1.22 inches (31.0 mm)  | 1.50 inches (38.1 mm)  | 0.98 inches (24.9 mm)  | 1.18 inches (30.0 mm)  |
| C1 | 1.50 inches (38.1 mm)  | 1.69 inches (42.9 mm)  | 1.18 inches (30.0 mm)  | 1.42 inches (36.1 mm)  |
| B2 | 1.69 inches (42.9 mm)  | 1.97 inches (50.0 mm)  | 1.42 inches (36.1 mm)  | 1.69 inches (42.9 mm)  |
| A3 | 1.97 inches (50.0 mm)  | 2.20 inches (55.9 mm)  | 1.69 inches (42.9 mm)  | 1.93 inches (49.0 mm)  |
| C2 | 2.20 inches (55.9 mm)  | 2.44 inches (62.0 mm)  | 1.93 inches (49.0 mm)  | 2.17 inches ( 55.1 mm) |
| B3 | 2.44 inches (62.0 mm)  | 2.68 inches (68.1 mm)  | 2.17 inches ( 55.1 mm) | 2.40 inches (61.0 mm)  |
| D2 | 2.68 inches (68.1 mm)  | 2.91 inches (73.9 mm)  | 2.40 inches (61.0 mm)  | 2.64 inches (67.0 mm)  |
| C3 | 2.91 inches (73.9 mm)  | 3.15 inches (80.0 mm)  | 2.64 inches (67.0 mm)  | 2.87 inches (72.9 mm)  |
| E2 | 3.15 inches (80.0 mm)  | 3.39 inches (86.1 mm)  | 2.87 inches (72.9 mm)  | 3.11 inches (79.0 mm)  |
| D3 | 3.39 inches (86.1 mm)  | 3.66 inches (93.0 mm)  | 3.11 inches (79.0 mm)  | 3.35 inches (85.1 mm)  |
| C4 | 3.66 inches (93.0 mm)  | 3.90 inches (99.0 mm)  | 3.35 inches (85.1 mm)  | 3.58 inches (90.9 mm)  |
| E3 | 3.90 inches (99.0 mm)  | 4.13 inches (104.9 mm) | 3.58 inches (90.9 mm)  | 3.82 inches (97.0 mm)  |
| D4 | 4.13 inches (104.9 mm) | 4.37 inches (111.0 mm) | 3.82 inches (97.0 mm)  | 4.06 inches (103.1 mm) |
| F3 | 4.37 inches (111.0 mm) | 4.53 inches (115.0 mm) | 4.06 inches (103.1 mm) | 4.29 inches (109.0 mm) |
| E4 | 4.53 inches (115.0 mm) | 4.62 inches (117.3 mm) | 4.29 inches (109.0 mm) | 4.53 inches (115.0 mm) |
| D5 |                        |                        | 4.53 inches (115.0 mm) | 4.62 inches (117.3 mm) |

Figure 4 Separation Table



The diagram in figure 5 shows how to adjust the separation of the sensors

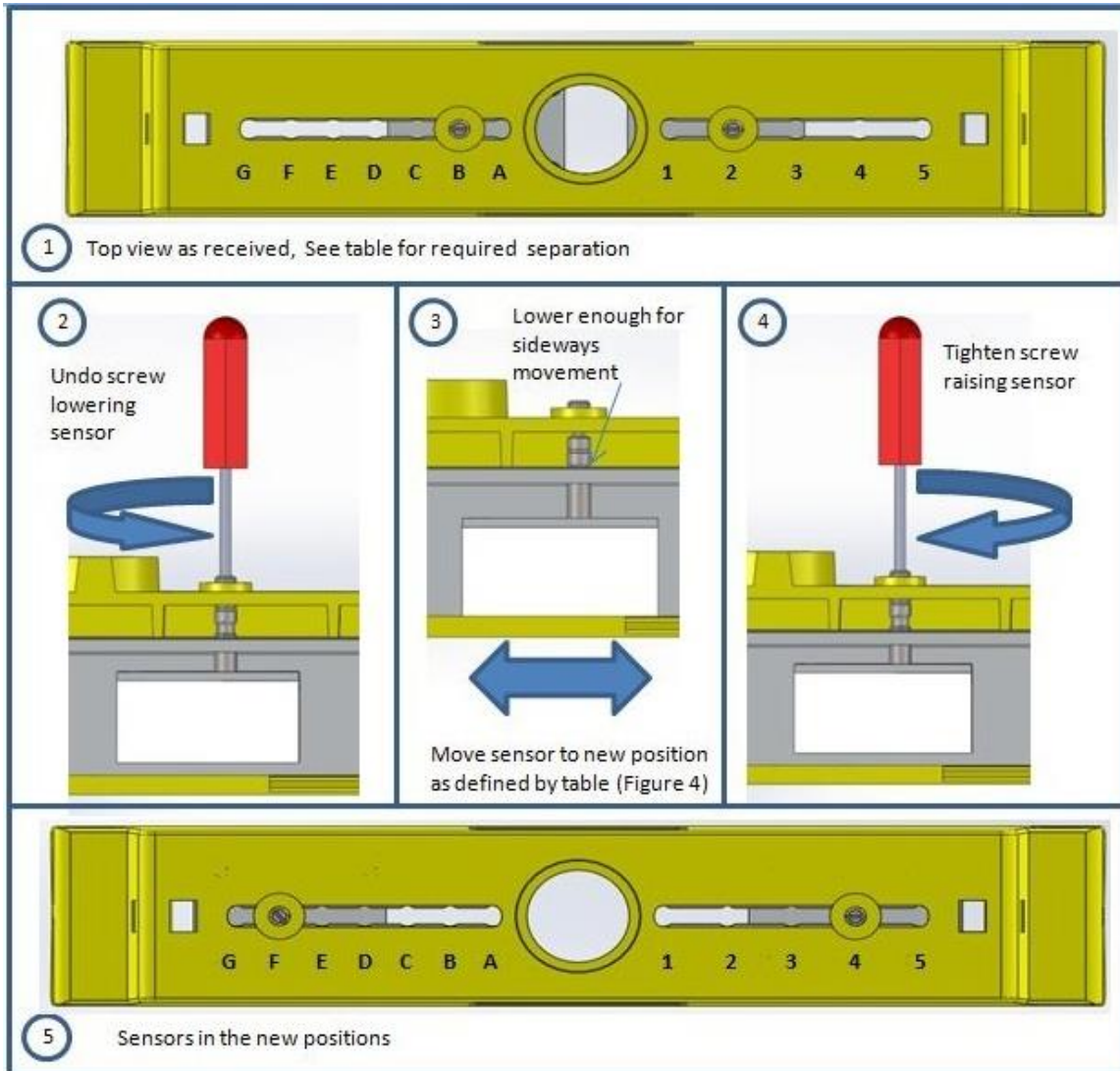

Figure 5 Separation Setting

### 4.3 Adaptors for small pipes

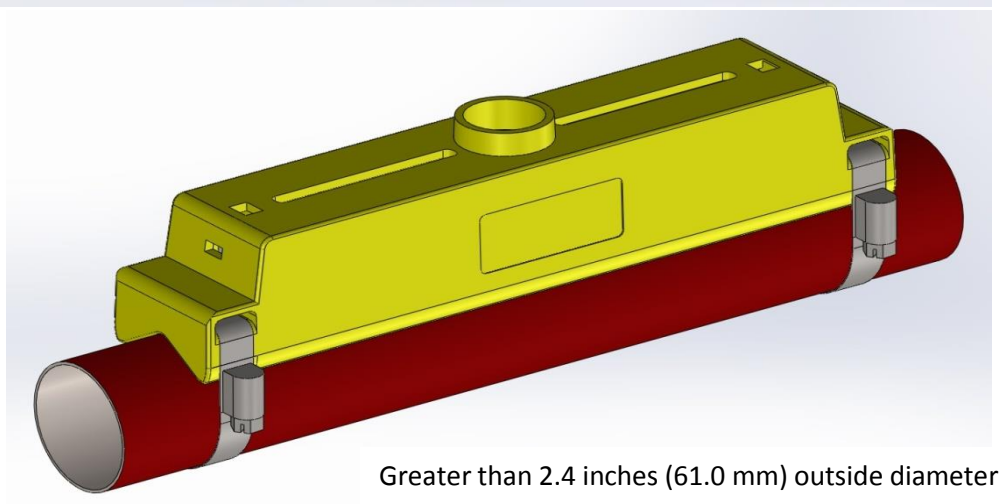
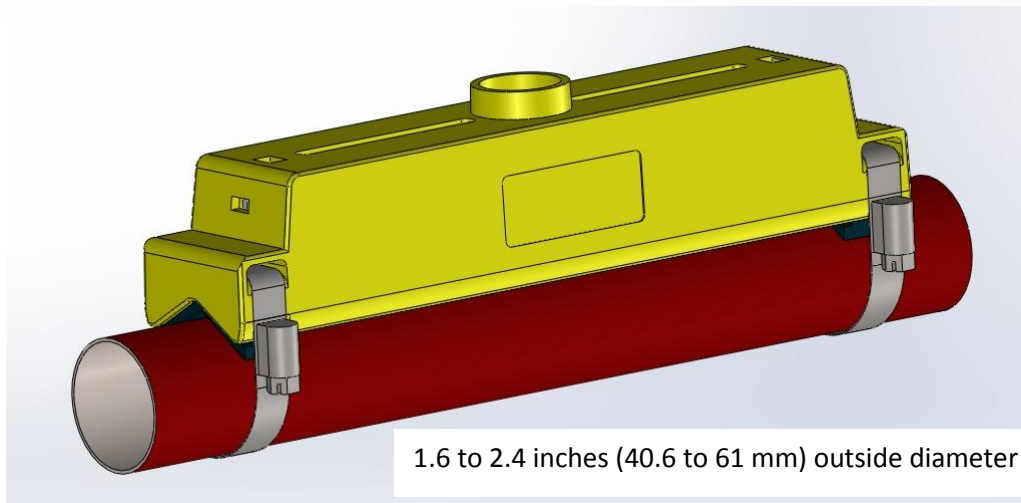
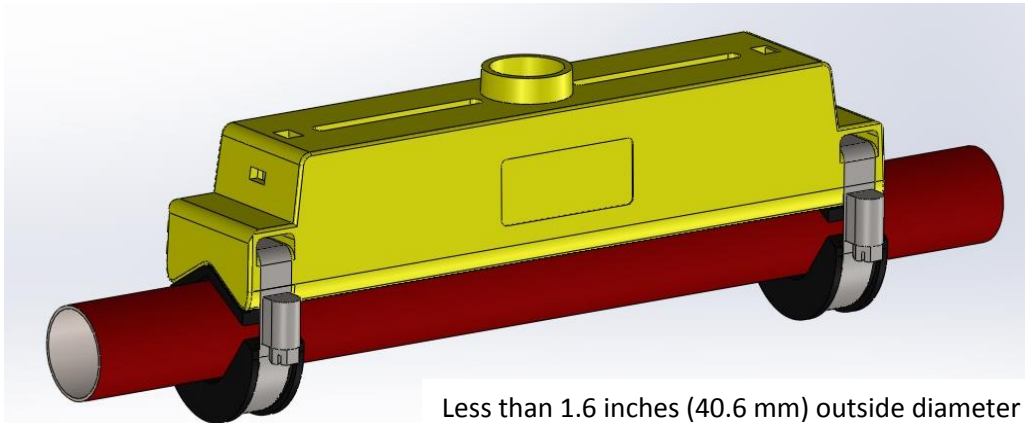

Figure 6 Pipe Adaptors

Adaptors are supplied for use on small pipes. The diagrams in figure 6 show how these are fitted around the pipe. The top pipe adaptor clips into the ends of the guide rail.

#### 4.4 Attaching the UFM to the pipe

Follow the five steps shown in Figure 7 below to attach the UFM to the pipe.



The grease provided in the syringe is applied to the center of the sensors as shown above.



Clamp guide rail and sensor assembly to pipe, using the supplied banding, and release sensor locking screws.



Connect power and sensors to the electronics assembly. Sensor leads can be connected either way round.



Click electronic assembly onto guide rails and sensor assembly

[Figure 7 Simple Steps to Attaching the UFM on the Pipe](#)

The locking screws and washers should be kept in case it is necessary to change the location of the guide rail and sensors. See the relocation instructions in section 9 for the procedure to do this.

## 4.5 UFM interface cable

The UFM interface cable supplied is a 6-core cable and is shown in Figure 8.

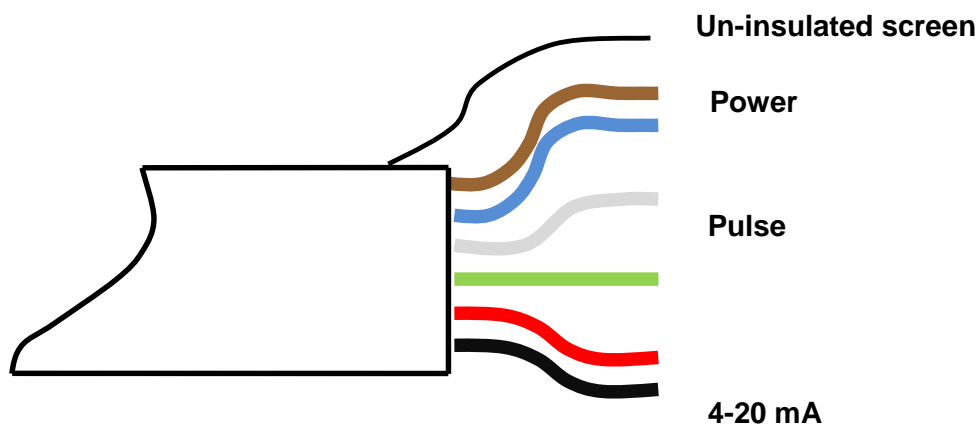







Figure 8 UFM Interface Cable

The polarity of the wires is as follows:

|   |                                      |
|---|--------------------------------------|
|  | 12/24 V Input (+)                    |
|  | 12/24 V Return (-)                   |
|  | Pulse Output                         |
|  | Pulse Return                         |
|  | 4-20 mA Output (+) (Polar Sensitive) |
|  | 4-20 mA Return (-) (Polar Sensitive) |

The un-insulated wire is the connection to the screen of the cable and should be earthed for full immunity to electrical noise.

## 4.6 Connecting the UFM to the Supply

The UFM will operate within the voltage range 12 – 24 V ac/dc. Connect the external power supply to the Brown and Blue wires of the six core cable. For full compliance with EMC regulation a 12 V supply is recommended for domestic and light industrial applications.

## 4.7 Pulse Output connection

The isolated pulse output is provided by a SPNO MOSFET relay which has a maximum load current of 500 mA and maximum load voltage of 48 V ac. The relay also provides 2500 V isolation.

The pulse output is available at the White and Green wires. Electrically this is a volt free contact closure.



#### **4.8 Current Output**

The isolated 4-20 mA is a current source and can drive into a maximum load of 620  $\Omega$ .

The 4-20 mA current output is available at the Red and Black wires. The polarities are shown in Figure 8.

The alarm current due to a flow outside the range specified or due to a loss of signal is set at 3.5 mA.

#### **4.9 Cable Screen**

For full immunity to electrical interference the screen of the cable should be connected to Earth.

## 5 Powering up for the first time

Powering up for the first time will initiate the sequence shown in Figure 9:

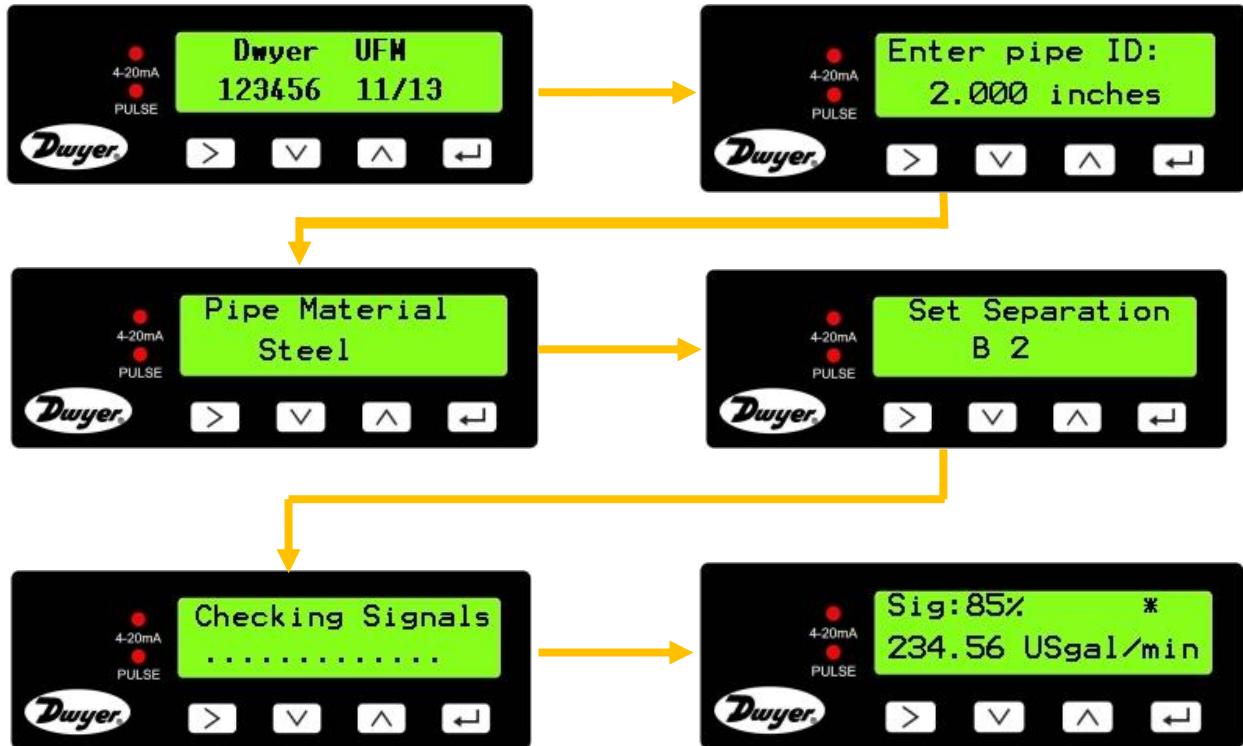
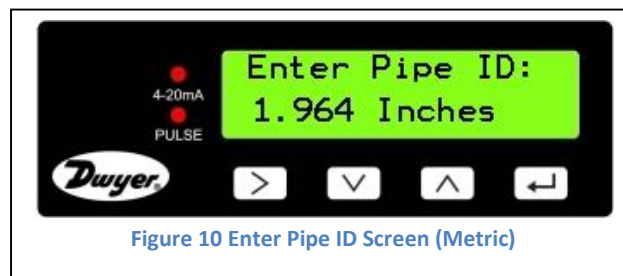

Figure 9 Powering the Unit Up

1. The startup screen is displayed for 5 seconds
2. The user enters the pipe ID and then the material by scrolling through the available list. (refer to section 5.1)
3. The UFM checks for a valid signal
4. If a valid signal is found, signal strength and flow magnitude are displayed. The direction of flow when powered up will be set as that for positive flow. The current output and pulse output will relate to the flow in this direction. If the flow is reversed then the flow rate will still be displayed but the activity indication will change from an asterisk to an exclamation mark. No pulses will be generated, and the current will go to the 3.5 mA alarm state if the flow is reversed.

## 5.1 How to enter the Pipe ID

Figure 10 shows the Enter Pipe ID screen after an initial power up.





Initially, the inches digit (1.964) will blink.

Press the  key to increment the inches digit (1.964) in the sequence 0, 1. Press once to increment digit, or hold key down to automatically scroll between 0 and 4.

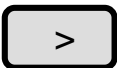
Press the  key to decrement the inches digit in the sequence 4 to 0. Press once to decrement digit, or hold key down to automatically scroll between 4 and 0.

Press the  key to move to the 0.1 inch digit (1.964). The 0.1 inch digit should now blink.

Increment the 0.1 inch digit in the sequence 0,1,2,3,4,5,6,7,8,9,0 using the

 key. Press once to increment digit or hold down to scroll through the numeric sequence. Decrement the 0.1 inch digit in the sequence 9,8,7,6,5,4,3,2,1,0,9 using the  key. Press once to increment digit or hold down to scroll through the numeric sequence.

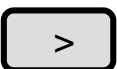
Press the  key to move to the 0.01 inch and 0.001 inch digits. The selected digit should now blink. Increment or decrement the digit in an identical manner to the 0.1 inch digit described above.

Press the  key to enter the Pipe ID numerical value, and move to the next screen.

Pipe material  
Plastic

Use  and  keys to scroll through the pipe materials.

Press the  To select the material and complete the setup procedure.



If any of the parameters need to be changed from the default values, for example different units are required, then the menu system must be activated via the password (see section 7).

## **5.2 Pulse output**

Pulse output can be set up to operate in two modes, namely volumetric and frequency.

### **5.2.1 Volumetric mode**

In Volumetric mode, each pulse output represents a measured volume of 10 gallons (default value). In Volumetric mode, with the Vol per Pulse set to 1 and the pulse width set to 25 ms, the maximum number of pulses that can be output (without storage) is  $1/(0.025 \times 2) = 20$  pulses per second. If the flow rate in the pipe is such that more than 20 pulses per second are generated, a Pulse Overflow error may eventually occur if the stored number of pulses exceeds 1000. To avoid this, set the Vol per Pulse to 100 gallons.

### **5.2.2 Frequency mode**

In Frequency mode, the pulse output frequency is proportional to the flow rate within a specified frequency range of 0 – 200 Hz.

## **5.3 4-20 mA Current output**

The default 4-20 mA output setting will be ON, and the 4-20 mA LED on the keypad will be illuminated. The default flow for 20 mA output will be automatically set depending on the pipe size. The default flow for 4 mA is 0. This can be changed, see section 7.

If the flow reading is greater than that set as the 20 mA value, or there is negative flow, or no flow signal can be detected, then an alarm current of 3.5 mA will be generated.

**Note:** The 4-20 mA current output is factory calibrated.



## 6 Subsequent Power-ON Sequence



If the power supply is cycled OFF then ON after the pipe ID has been entered, all subsequent start-ups will use the same configuration as was previously entered. If the configuration needs to be changed for any reason, the user can make use of the password-controlled menu as described in section 7.

## 7 Password Controlled Menus

The password controlled menu allows the user some flexibility to change the default settings:

### User Password (71360):

- Change the dimensions from mm to inches or vice-versa.
- Change from Flow to Velocity Measurement
- Change the system units liters/m<sup>3</sup> or Impgal/USgal
- Change the flow units l/s, l/min or gal/s, gal/min or USgals/s, USgals/min
- Change the default value for Flow at Maximum Current
- Change the default setting for Flow at Minimum Current
- Change the Pulse Output type
- Change the Pulse output parameters

Press the  to get to the screen prompting for the password, which is entered using the method shown in 7.1.2. To exit the password controlled menu navigate to the Exit screen and press . To exit the password entry screen without entering a password wait until the flow screen is displayed.



### 7.1 General procedure for changing menu settings

#### 7.1.1 Selection menus

When a password controlled menu is selected the procedure for changing the default setting is the same for all menus. For example, consider the Flow Units menu shown in Figure 11.



Figure 11 Flow Units menu







The default value 'USgal/m' will blink to indicate that this is the current setting. To change to 'USgal/h', press the  key. Now the 'USgal/h' units will blink to indicate that this is now the selected units. Press the  key to confirm the change.

### 7.1.2 Data entry menus

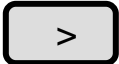
Menus containing a numeric value can be altered using the following procedure. For example, consider changing the Flow at maximum current from the default setting 1000 gallons as indicated in Figure 12. to 1258 gallons.

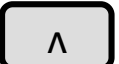



Figure 12 Example of a Data entry screen

- Press the  key twice to select the hundreds unit (01**0**00.0) which will now blink
- Press the  key twice to increment the hundreds unit from 0 to 2 (01**2**00.0)
- Press the  key once to select the tens unit (012**0**0.0) which will now blink
- Press the  key five times to increment the tens unit from 0 to 5 (012**5**0.0)
- Press the  key once to select units (0125**0**.0) which will now blink
- Press the  key twice to decrement the units from 0 to 8 (0125**8**.0)
- Press the  key to confirm the change

All numeric data menus can be changed in this way.

### 7.2 User Password controlled menu structure

Ensure that the instrument is in Flow Reading mode then press the  key to go to the user password menu. Enter 71360 using the procedure explained in section 7.1.2. to enter the password.

The flow chart shown in Figure 13 shows the user password menu structure. To skip over any menu item that should remain unchanged, simply press the  key.



71360 MENU

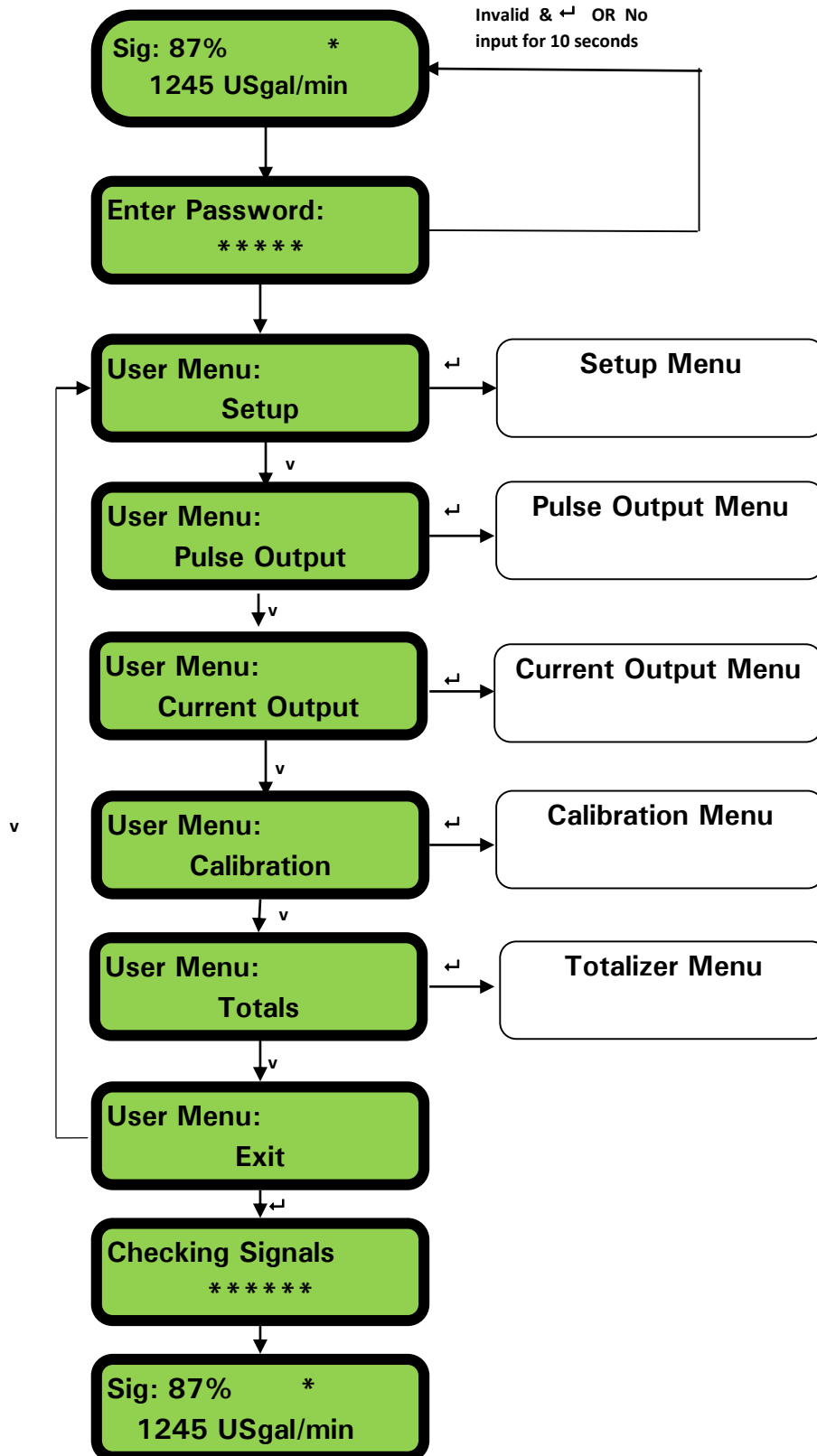

Figure 13 Main Menu

SETUP MENU

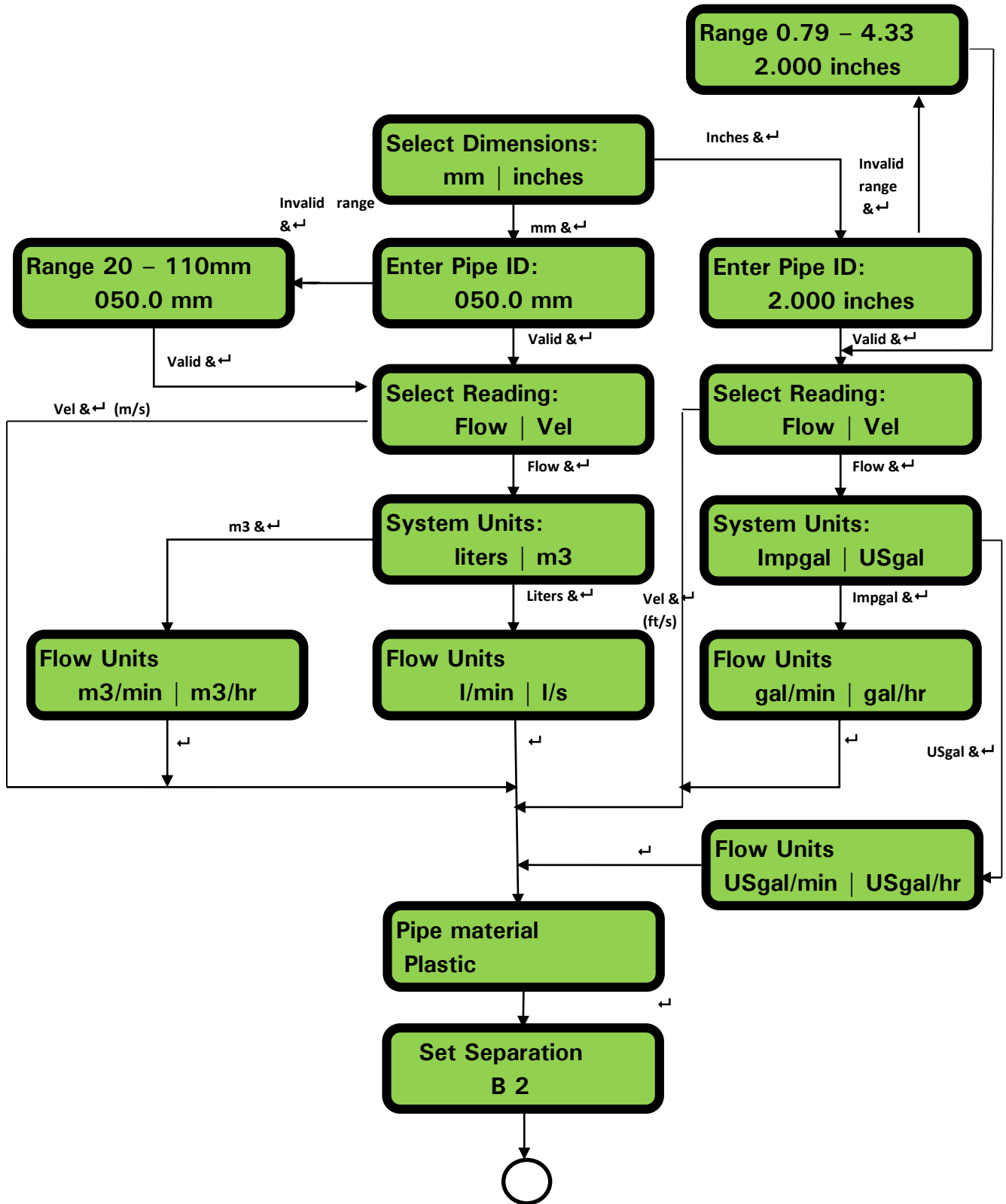
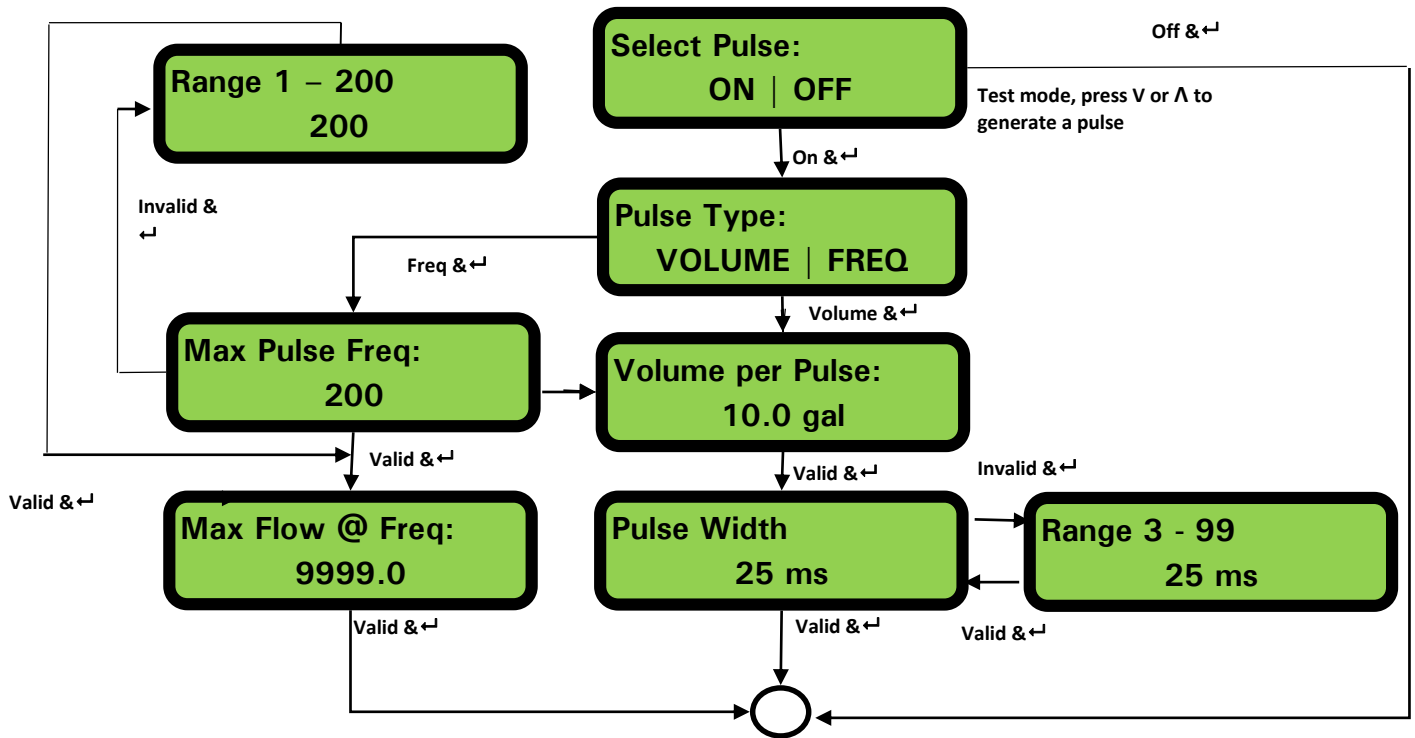

Figure 14 Setup Menu

### PULSE OUTPUT MENU



### TOTALIZER MENU

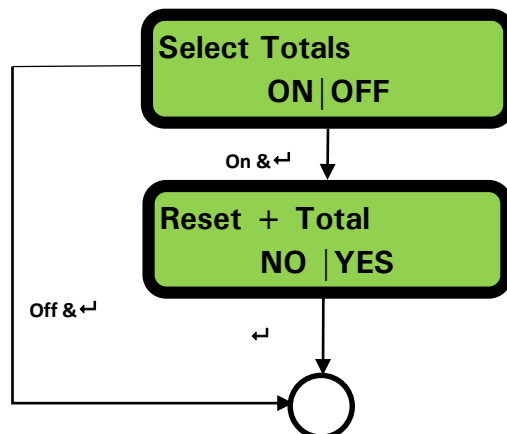
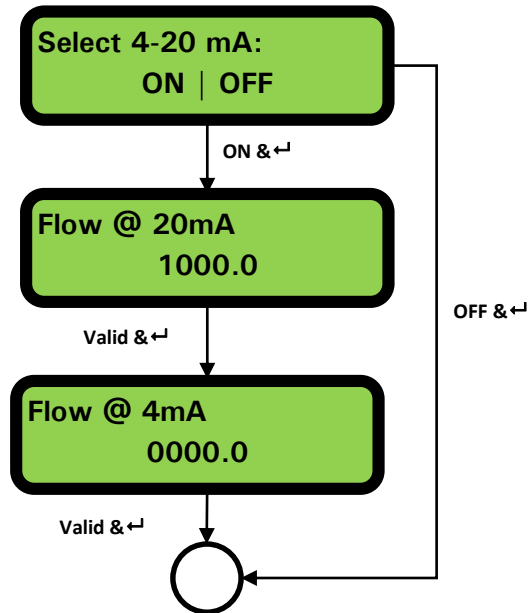

Figure 15 Pulse Output & Totalizer Menus

If the Total is turned on then the display will alternate between the flow reading and the total. Either display can be held for 30 seconds by pressing the key.

### CURRENT OUTPUT MENU



### CALIBRATION MENU

Set Zero cut-off to 0.00 before using Zero Offset and restore to 0.05 or more afterwards

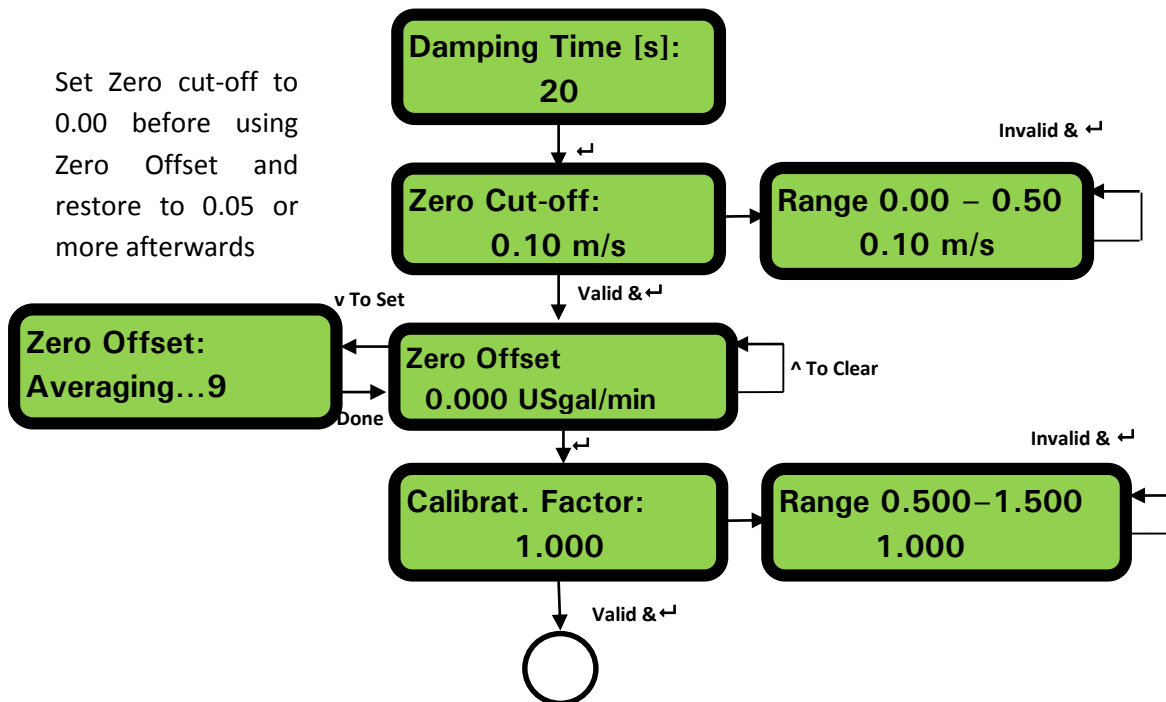

Figure 16 Current Output & Calibration Menus

## 8 Diagnostics Menu

The diagnostics menu provides some additional information about the flowmeter and its setup. The menu can be accessed by pressing the key from the main flow-reading screen. The menu shown below describes the various diagnostics items.

### DIAGNOSTICS MENU

Press To exit the Diagnostics menu

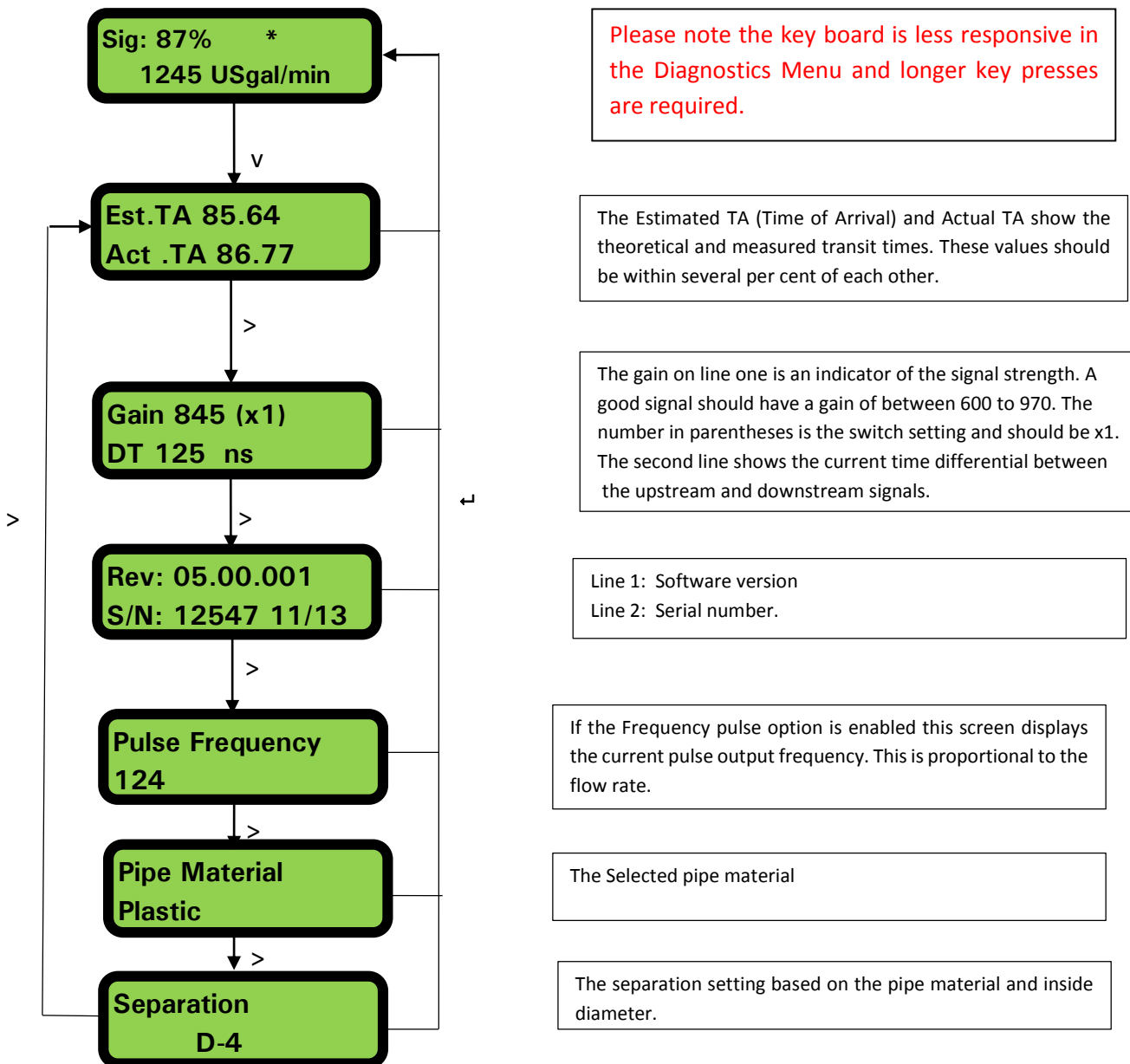

Figure 17 Diagnostics Menu

## 9 Relocation of guide rail

If it is necessary to relocate the guide rail and sensor assembly use the following procedure

1. Remove complete assembly from the pipe
2. Insert a small screwdriver in the hole at the end of the guide rail moulding and lever up the clip holding the electronics assembly by pressing down on the screwdriver as shown in figure 18.
3. Repeat 2 on the other end and then pull off the electronics unit.

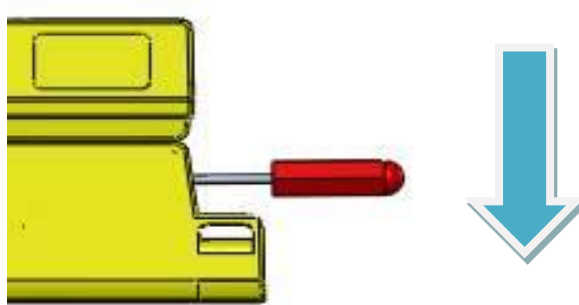

Figure 18

4. Disconnect the sensors
5. Remove the original grease from the sensors
6. Push the sensor blocks into the guide rail so that the washers and locking screws can be refitted.
7. Place a bead of grease down the center of the sensor block using the syringe provided. See illustration on fitting the guide rail to the pipe for recommended bead size.
8. Follow the original procedure for installing the guide rail on the pipe.





## 10 Appendix I – UFM Specification

Table 1 lists the UFM Product Specification.

| <b>General</b>                      |   |
|-------------------------------------|---|
| Measuring Technique                 | Transit time  |
| Measurement channels                | 1   |
| Timing Resolution                   | ±50 ps  |
| Turn down ratio                     | 200:1   |
| Flow velocity range                 | 0.1 to 10 m/s   |
| Applicable Fluid types              | Clean water with < 3% by volume of particulate content.   |
| Accuracy                            | ±3% of flow reading for flow rate >0.3 m/s  |
| Repeatability                       | ±0.5% of measured value   |
| Selectable units                    | Velocity: m/s, ft/s<br>Flow Rate:l/s, l/min, gal/s, gal/min, USgal/s, USgal/min, m <sup>3</sup> /min, m <sup>3</sup> /hr<br>Volume: liters, m <sup>3</sup> , gals, USgals |
| Languages supported                 | English only  |
| Power input                         | 12 – 24 V ac or dc  |
| Power consumption                   | 7 VA maximum  |
| Cable                               | 5 m screened 6 core   |
| <b>Pulse Output</b>                 |   |
| Output                              | Opto-isolated MOSFET volt free normally open contact.   |
| Isolation                           | 2500V   |
| Pulse width                         | Default value 25 ms; programmable range 3 – 99 ms   |
| Pulse repetition rate               | Up to 166 pulses/sec (depending on pulse width)   |
| Frequency mode                      | 200 Hz maximum  |
|                                     |   |
| Maximum load voltage/current        | 48V AC / 500mA  |
| <b>Current Output</b>               |   |
| Output                              | 4 – 20 mA   |
| Resolution                          | 0.1% of full scale  |
| Maximum load                        | 620 Ω   |
| Isolation                           | 1500 V opto-isolated  |
| Alarm current                       | 3.5 mA  |
| <b>Enclosure</b>                    |   |
| Material                            | Plastic Polycarbonate   |
| Fixing                              | Pipe mountable  |
| Degree of Protection                | IP54  |
| Flammability Rating                 | UL94 V-0  |
| Dimensions                          | 10 inches x 2 inches x 3.6 inches (electronics + guide rail)  |
| Weight                              | 1.1 lb  |
| <b>Environmental</b>                |   |
| Pipe temperature                    | 32°F to 185°F (0°C to 85°C)   |
| Operating temperature (Electronics) | 32°F to 122°F (0°C to 50°C )  |
|                                     |   |



|                     |  |
|---------------------|--|
| Storage temperature | 14°F to 140 °F (-10°C to 60°C)         |
| Humidity            | 90% RH at 122°F Max                    |
| <b>Display</b>      |  |
| LCD                 | 2 line x 16 characters                 |
| Viewing angle       | Min 30°, Max 40°                       |
| Active area         | 3.27 inches (W) x 0.74 inches(H)       |
| <b>Keypad</b>       |  |
| Format              | 4 key tactile feedback membrane keypad |

## 11 Appendix II – Default values

The settings will be configured at the factory for either metric or imperial units. Table 2 lists the metric default values.

**Table 2 System Default Values**

| Parameter           | Default Value        |
|---------------------|----------------------|
| Dimensions          | mm                   |
| Flow Rate           | l/min                |
| Pipe size           | 50 (mm)              |
| 4-20 mA             | On, 4-20 mA selected |
| Flow at Max Current | Equivalent to 2m/s   |
| Flow at Min Current | 0                    |
| Pulse Output        | On                   |
| Volume per Pulse    | 10 liters            |
| Pulse Width         | 25 ms                |
| Damping             | 20 seconds           |
| Calibration Factor  | 1.000                |
| Zero Cut-off        | 0.10 m/s             |
| Zero Offset         | 0.000 l/min          |

Table 3 lists the default values when Imperial dimensions are selected.

**Table 3 System Default Values**

| Parameter           | Default Value          |
|---------------------|------------------------|
| Dimensions          | inches                 |
| Flow Rate           | USgal/min              |
| Pipe size           | 2 (inches)             |
| 4-20 mA             | On, 4-20 mA selected   |
| Flow at Max Current | Equivalent to 6.5 ft/s |
| Flow at Min Current | 0                      |
| Pulse Output        | On                     |
| Volume per Pulse    | 10 US gallons          |
| Pulse Width         | 25 ms                  |
| Damping             | 20 seconds             |
| Calibration Factor  | 1.000                  |
| Zero Cut-off        | 0.10 m/s ( 0.3 ft/s)   |
| Zero Offset         | 0.000 gal/min          |



## 12 Appendix III – Error and Warning Messages

### 12.1 System errors

There are three possible 'System Error' messages that can be displayed. They are:

1. **Poor Signal.** The unit is unable to detect a signal from one or both transducers. If this message persists the sensors will need to be relocated.
2. **Pulse Overflow.** The value for the 'Vol per pulse' is set too low. Increase the Vol per Pulse setting in the password-controlled menu.
3. **No BBME:** This indicates a unit failure. Reset the unit by turning the power on and off. Contact Dwyer Instruments, Inc. if the problem persists.

### 12.2 Warnings

These generally advise the user that the data entered is out of the specified range.

1. When an invalid Pipe ID is entered, the warning message shown below is displayed, prompting the user to enter a value between 0.79 and 4.33 inches.

Range 0.79 – 4.33  
0.000 inches

2. When the 4-20 mA current output is turned ON, the Flow at Maximum and Minimum current can be changed under password control. The valid range is 0 – 99999.0 If an invalid value is entered the following warning message is displayed:

Range 0 - 99999  
0000.0

3. When programming a Frequency Pulse output the frequency is limited to the range 1 to 200 Hz. If an invalid value is entered then the following warning message is displayed.

Range 1 - 200  
200Hz



4. When programming a Volume Pulse output the pulse width is limited to the range 3 to 99 ms. If an invalid value is entered then the following warning message is displayed.

**Range 3 - 99  
00ms**

5. When programming the Zero Cut-off this is limited to the range 0.000 to 0.500 m/s. If an invalid value is entered then the following warning message is displayed.

**Range 0.00 – 0.50  
0.00**

6. When programming the Calibration Factor this is limited to the range 0.5 to 1.5. If an invalid value is entered then the following warning message is displayed.

**Range 0.50 – 1.50  
0.000**

## 13 Maintenance/Repair

Upon final installation of the model UFM, no routine maintenance is required. The model UFM is not field serviceable and should be returned if repair is needed. Field repair should not be attempted and may void warranty.

## 14 Warranty /Return

Refer to “Terms and Conditions of Sale” in our catalog or on our website. Contact customer service to receive a Return Goods Authorization number before shipping you product back for repair. Be sure to include a brief description of the problem plus any relevant application notes.