

AT-101NA-1800 (VSO / DTC004)

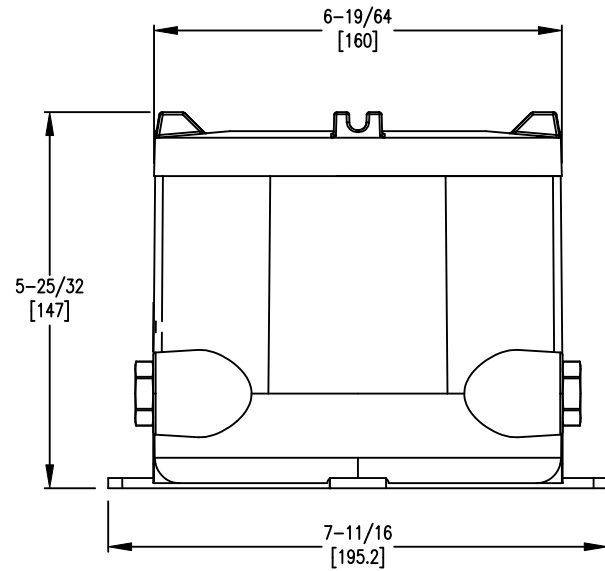

AT-101NA-1800 (VSO / DTC004 / BACKSIDE VIEW)

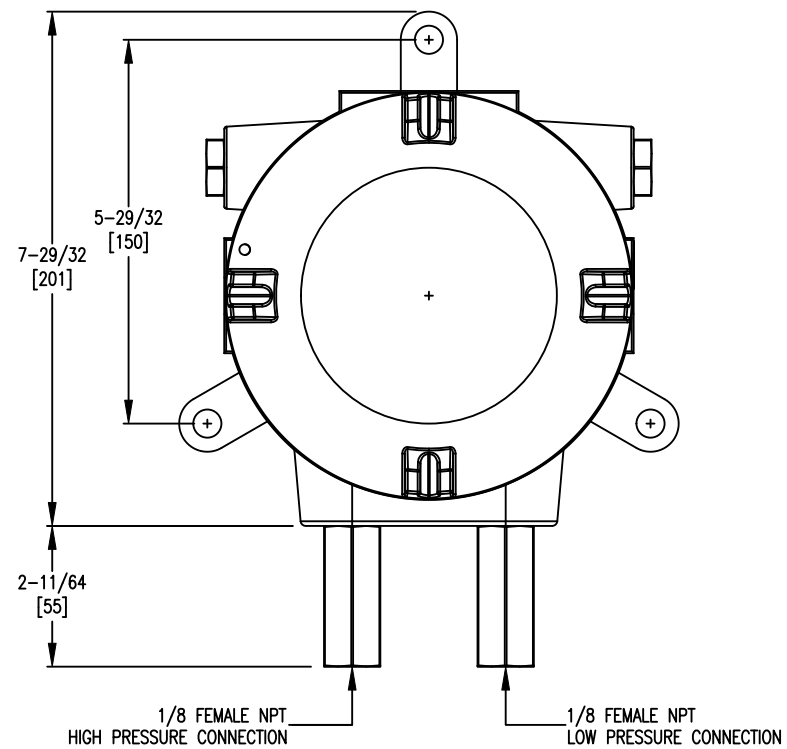
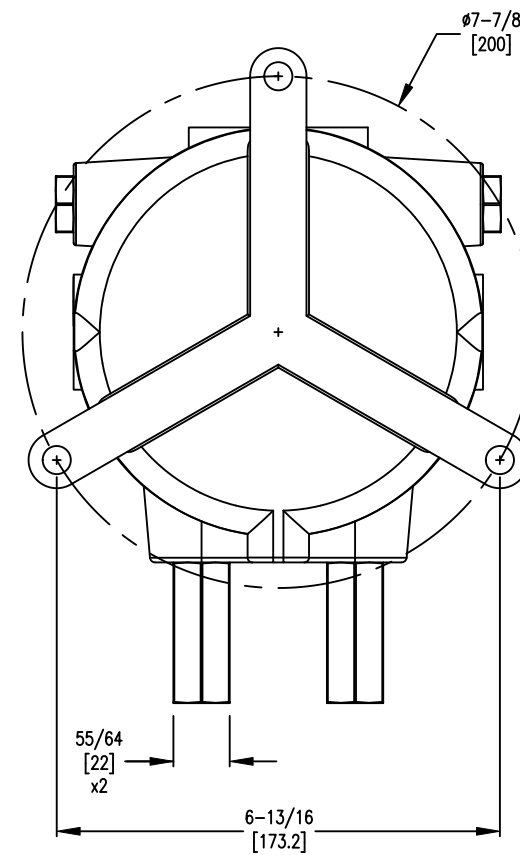

Ⓢ = CRITICAL DIMENSION
 STANDARD TOLERANCES UNLESS NOTED:
 ALL DECIMAL DIMENSIONS ± .005
 ALL ANGLES ± 1°

SCALE 3:1

			DATE 09-08-20	NAME ARTWORK, SERIES 1800 WITH ATEX/IECEX CERTIFIED ALUMINUM ENCLOSURE STD PRESSURE PORT NO VENTING VALVE (FOR REFERENCE ONLY)	MATERIAL
			DWN BY DPR		FINISH
			CHKD KAS		DWYER INSTRUMENTS, INC. MICHIGAN CITY, INDIANA 46360 U.S.A.
			APPD FAE	ACAD2002	
NO.	CHANGES	BY/DATE			FR. NO. 701459-00
NOTICE: This drawing and the principles and elements of design embodied therein are the exclusive property of DWYER INSTRUMENTS, INC. and are not to be communicated, disclosed, reproduced or used except as previously authorized in writing by such corporation and must not be submitted to outside parties for examination without the written consent of said corporation.					3